

nickelodeon

TEENAGE MUTANT NINJA

TURTLES



## BAXTER™

Mutation Lab | Laboratoire Mutation | Laboratorio mutante | Laboratório de Mutação | Laboratorio Mutazioni | Mutationslabor | Laboratorium mutacji Mutatielab | Лаборатория мутаций

4x  
AM76558APG



2x  
AM19392F



1x  
AM17506F



4x  
AM17018KF



1x  
AM74723F



1x  
AM74722F



1x  
AM72030Z



2x  
AM09393APG



1x  
AM19381APG



2x  
AM09023APG



2x  
AM76777DH



4x  
AM09622KF

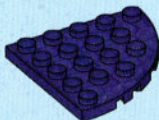

1x  
AM74409APG

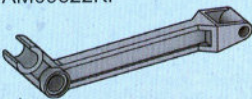

1x  
AM17383APG



2x  
AM77048APG



1x  
AM77043AQD

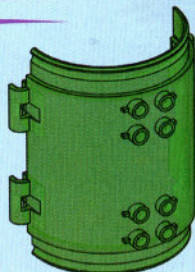

1x  
AM76955AQD

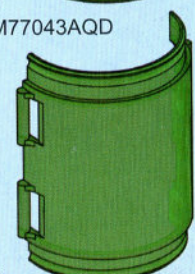

1x  
FIG-DMX19-A



1x  
FIG-DMX50-C



3x  
AM76818APG



1x  
FIG-DMX50-A





⚠ WARNING:  
CHOKING HAZARD. - Small parts.  
Not for children under 3 years.

⚠ ATTENTION:  
DANGER D'ÉTOUFFEMENT. - Présence de petits éléments.  
Ne convient pas aux enfants de moins de 3 ans.

⚠ تحذير:  
خطر الاختناق - قطع صغيرة  
غير صالحة للأطفال أقل من 3 سنوات.

⚠ 警告:  
噎住危險。包含有小部件  
不适合3岁以下的小孩玩。

⚠ 警告:  
のどにつまる危険 小さな部品が含まれています  
3歳以下の子供には与えないで下さい。

ADVERTENCIA: Peligro de asfixia. Juguete no recomendado para menores de 3 años, porque contiene piezas pequeñas que podrían provocar asfixia en casode ser ingeridas o inhaladas por el/la niño/a.

ATENÇÃO: Não recomendável para crianças com menos de 36 meses. Contém peças pequenas capazes de criar risco de asfixia.

ATTENZIONE: Contiene pezzi di piccole dimensioni.

ACHTUNG: Kleine Teile.

OSTRZEŻENIE: Małe części

WAARSCHUWING: Kleine onderdelen

ПРЕДУПРЕЖДЕНИЕ: Мелкие детали

ADVARSEL: Små dele.

VARNING: Smådelar

ADVARSEL: Små deler.

VAROITUS: Pieniä osia

ΠΡΟΣΟΧΗ: Περιλαμβάνονται μικρά κομμάτια.



Please read these instructions carefully before first use and keep them for future reference.  
Il est recommandé de lire attentivement ce feuillet avant la première utilisation et de le conserver pour référence future.

Leer estas instrucciones cuidadosamente antes de la primera utilización y guardarlas para referencia futura.

Leia as instruções antes do primeiro uso e guarde-as para futura referência.

Leggere le istruzioni prima di cominciare ad usare il gioco e conservarle per reference future.

Die Gebrauchsanleitung bitte durchlesen und aufbewahren.

Proszę uważnie przeczytać instrukcję obsługi przed pierwszym użyciem, a następnie zachować ją na przyszłość.

Wij raden u aan deze handleiding zorgvuldig te lezen en te bewaren voor eventuele raadpleging op een later tijdstip.

Внимательно прочитайте инструкцию перед первым использованием и сохраните ее для дальнейшего использования.

Vær venlig at læse disse instruktioner omhyggeligt inden ibrugtagen og opbevar dem til fremtidigt brug.

Läs noggrant igenom dessa instruktioner innan du använder produkten för första gången och spara dem för ev. framtida frågor.

Les disse instruksjonene nøye før første gangs bruk, og ta vare på dem for fremtidige oppslag.

Les nämä ohjeet huolellisesti ennen ensimmäistä käyttöä ja säilytä ne myöhempää tarvetta varten.

Διαβάστε αυτές τις οδηγίες προσεκτικά πριν χρησιμοποιήσετε το προϊόν για πρώτη φορά και φυλάξτε τις για μελλοντική αναφορά.

يرجى قراءة هذه التعليمات بدقة قبل البدء بالاستعمال والاحتفاظ بها كمرجع للمستقبل

请在初次使用前仔细阅读这些指示，并保留它们以便未来参考。

初めてご使用になる前に、この説明書をよくお読みください。また、本書は将来いつでも参照できるように保管してください。

U.S Patent N° D714,887

TMNT.MEGABLOKS.COM

© 2016 Viacom Overseas Holdings C.V. All Rights Reserved. Teenage Mutant Ninja Turtles and all related titles, logos and characters are trademarks of Viacom Overseas Holdings C.V.



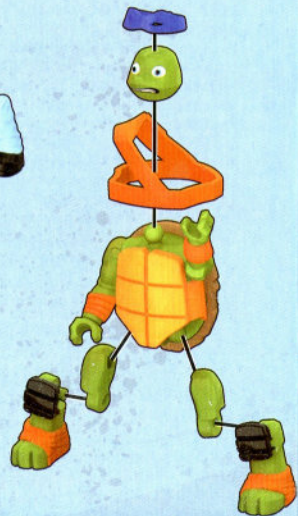
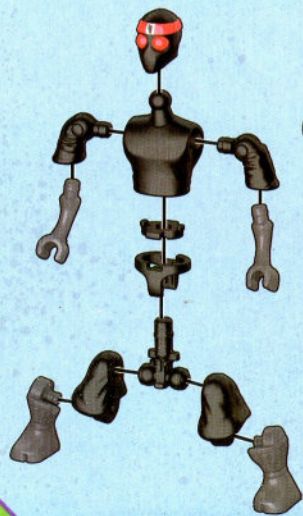
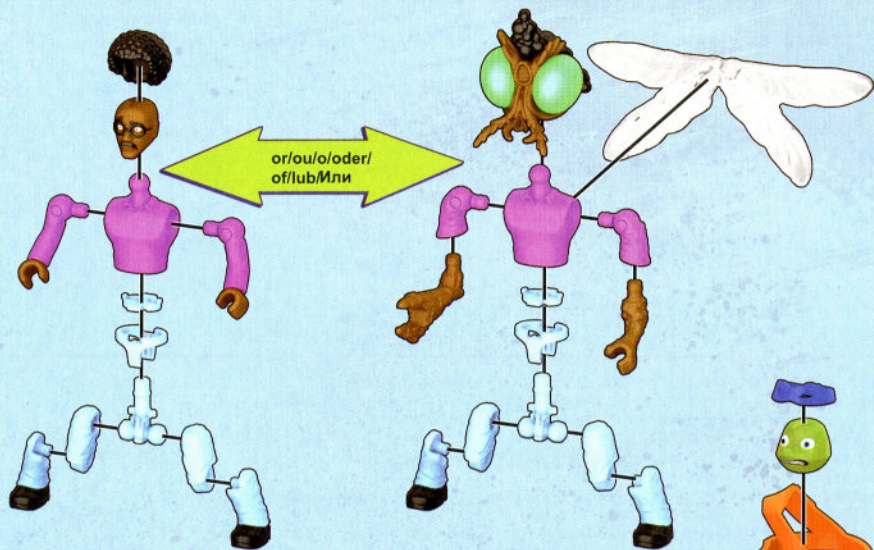



1



4x

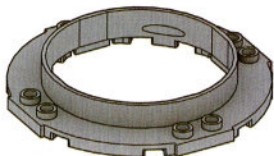

1x

2



4x

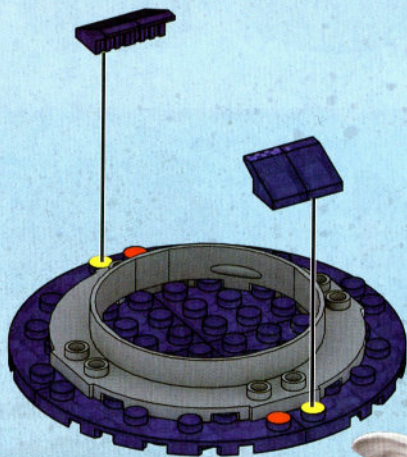
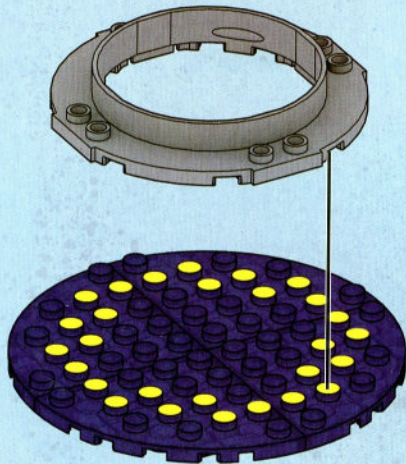

3

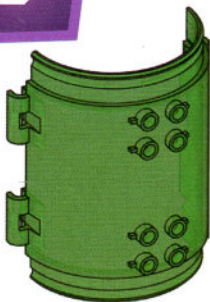

1x

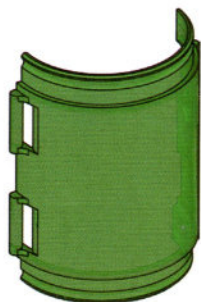

1x

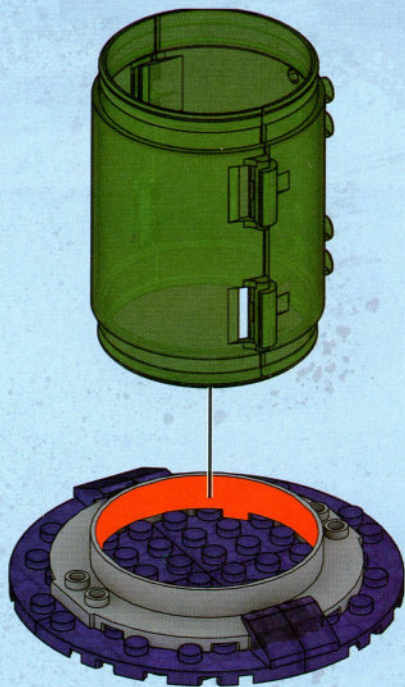
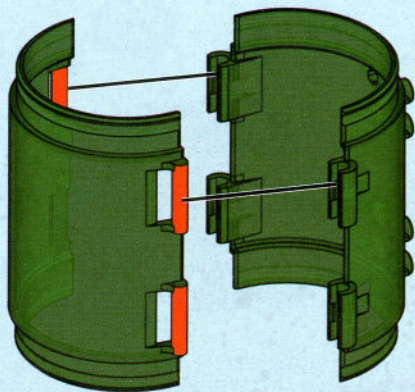



4



1x

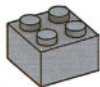

2x

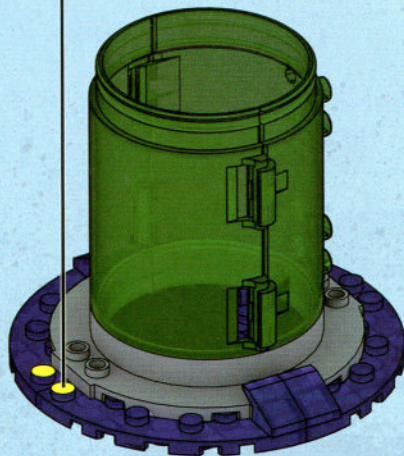
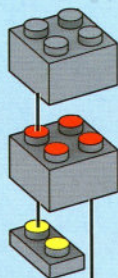

5



4x

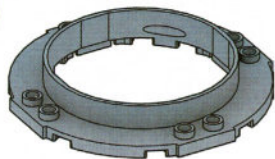

1x

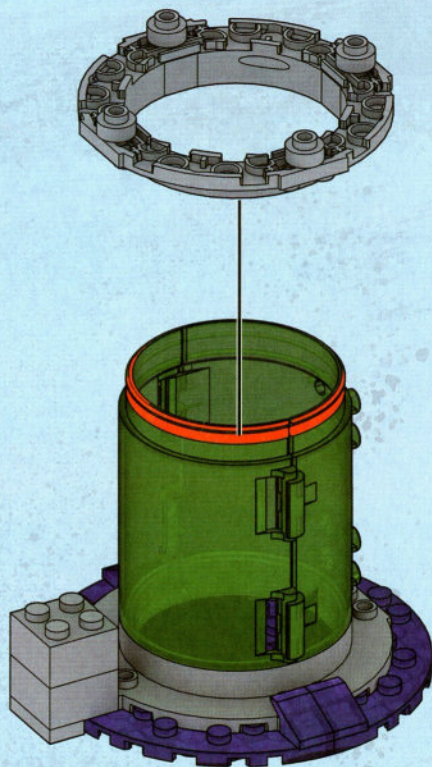
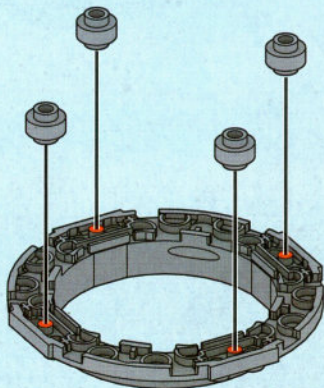



**6**



2x



1x



1x



1x



1x

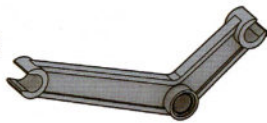

1x

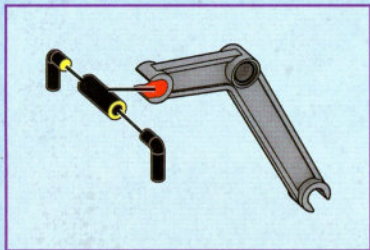

**1**

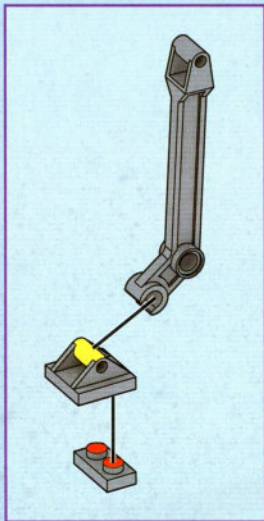

**2**

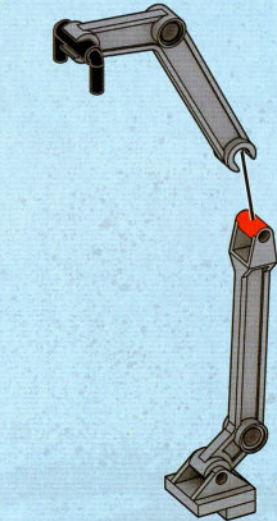

**3**



7

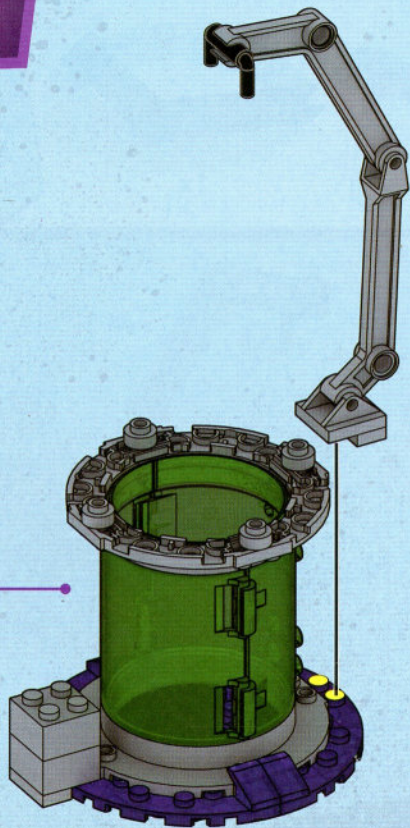

8



1x



1x

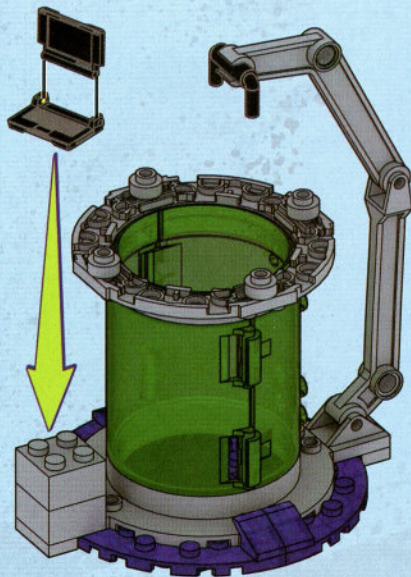











**TURTLE POWER | PODER DE TORTUGA NINJA  
 PODER DAS TARTARUGAS NINJA | МОС ЗОЉВИ  
 СИЛА ЧЕРЕПАШЕК**

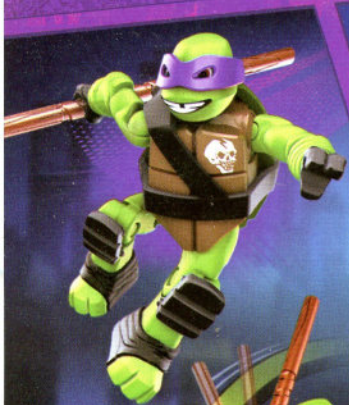

**ZIPLINE ACTION! | ACTION SUR FILIN!  
 ¡ACCIÓN DE CUERDA DE ESCAPE!  
 ANDA DE SLIDE! | AZIONE ECCLATANTE!  
 SEIL-ACTION! | TYROLKA!  
 ЗИПЛИНАСТІЕ! | СКОРОСТНОЙ СПУСК!**



**DOUBLE SLASHING ACTION!  
 ACTION DOUBLE FRAPPE!  
 ¡ACCIÓN DE DOBLE ATAQUE!  
 DUPLO ATAQUE!  
 DOPPIA AZIONE DEVASTANTE!  
 DOPPELTE SCHLAG-ACTION!  
 PODWOJNE CIĘCIE!  
 ДУБЛЕ АСТІЕ!  
 ДВОЙНЫЕ УДАРЫ!!**

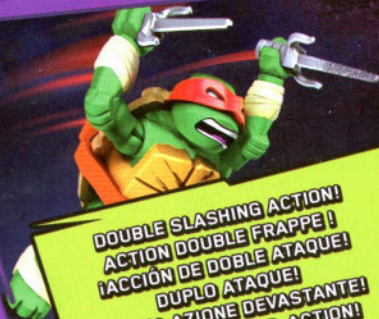

**SLASHING ACTION! | ACTION DE FRAPPE!  
 ¡ACCIÓN DE ATAQUE! | MOVIMENTOS DE BRACOS!  
 AZIONE DEVASTANTE! | SCHLAG-ACTION!  
 CIĘCIE! | WAT EEN AСТІЕ! | ФУНКЦІЯ УДАРОВ!**





YOU CAN COLLECT THEM ALL! | À COLLECTIONNER!  
 ¡COLECCIONALOS TODOS! | COLEZIONE TODOS!  
 COLEZIONALI TUTTI! | DU KANNST SIE ALLE SAMMELN!  
 MOŻESZ ZEBRAĆ JE WSZYSTKIE! | VERZAMEL ZE  
 ALLEMAAL! | ТЫ МОЖЕШЬ СОБРАТЬ ИХ ВСЕХ!



**DONNIE™**

DMX21



**FOOT SOLDIER™**

DMX21



**KRAANG™**

DMX21



**LEO™**

DMX21



**RAPH™**

DMX21



**MIKEY™**

DMX21



**SHREDDER™**

DMX21



**MIKEY™**

DMX27



**RAPH™**

DMX32



**LEO™**

DMX34



**RAPH™**

DMX35



**DONNIE™**

DMX37



**MIKEY™**

DMX38



**BAXTER™**

DMX50



**FOOT SOLDIER™**

DMX50



**LEO™**

DMX50



**MIKEY™**

DMX51



**MOUSERS™**

DMX51



**CASEY JONES™**

DMX52



**DONNIE™**

DMX62



**RAPH™**

DMX64



**SHREDDER™**

DMX64



**FOOT SOLDIER™**

DMX55



**LEO™**

DMX55



**TIGER CLAW™**

DMX55



VISIT | VISITE | VISITA | VISITA | VAI SU | AUF | WIĘCEJ | GA NAAR | ПОСЕТИТЕ ВЕСАЙТ  
**TMNT.MEGABLOKS.COM**

FOR MORE TURTLES ACTION! / POUR ENCORE PLUS D'ACTION TORTUES NINJA!  
PARA MÁS ACCIÓN DE TORTUGAS NINJA! / PARA MAIS AÇÃO COM AS TARTARUGAS NINJA!  
PRZYBÓD Z 206WIAMI NA | FINDET MÅN NOCH MEHR TURTLES-ACTION!  
ДРУГИЕ ИГРЫ С ЧЕРЕПАШКАМИ



©2016, MEGA Brands Inc. ® & ™ MEGA Brands Inc. Printed in China. AD-DMX50-01

Each sold separately and subject to availability. / Tous vendus séparément. Certains produits peuvent ne pas être commercialisés. / Se venden por separado y están sujetos a disponibilidad. / Vendidos em separado e sujeitos à disponibilidade. / Ognuno in vendita separatamente secondo disponibilità. / Alle Artikel separat erhältlich. Einige Artikel werden nicht in allen Ländern vertrieben. / Sprzedawane oddzielnie w zależności od dostępności. / Per stuk verkrijgbaar en niet overal leverbaar. / Каждый продукт продается отдельно, в зависимости от наличия. / Sælges separat og så længe lager haves. / Alla delar säljs separat så långt lagret räcker. / Hver leke selges separat så langt lageret rekker. / Jokainen tuudään erikseen, saatavuus voi vaihdella. / Το κάθε ένα πωλείται ξεχωριστά και ανάλογα με τη διαθεσιμότητα. / بائع كل منها على حدة وتخصيص لثوفاها. / 每件单独出售，并且视库存情况而定。 / それぞれ在庫状況に従って個別に販売されます。